

BT01000-AlphaSA-100ms 0.5MHz-150MHz 1kW

- Scientific and Industrial Applications



The BT-AlphaSA series is a range of class AB RF power amplifiers covering the 500kHz to 150MHz frequency range.

- Rugged, solid-state design - high reliability
- Extremely high phase and amplitude stability
- Very fast pulse rise/fall times
- High linearity
- Very low interpulse noise
- Competitively priced

RF Specifications

Type	Class AB MOSFET
Rated Power	1000W minimum PEP for input power of 0dBm
P1dB	800W minimum Minimum output power at P1dB compression
Gain	60dB minimum
Frequency	0.5MHz-150MHz
Gain flatness	±1.5dB maximum (measured at 1/10th rated output power)
Max. duty cycle	20% Maximum GATE duty cycle
Max. pulse width	100ms Maximum GATE pulse width
Rated power in CW mode	100W CW operation is automatically available at output power level less than approx. 10% of full rated power
Pulse droop	0.5dB maximum Measured at max. pulse width at P1dB level
Pulse rise and fall times	Risetime: 200ns typical Falltime: 100ns typical using a pre-gated RF input signal
Gate rise and fall times	Risetime: 300ns typical Falltime: 150ns typical
Gate delay	Rising edge: 1µs typical Falling edge: 500ns typical Rising edge measured from rising edge of GATE pulse to 90% RF output voltage. Falling edge measured from falling edge of GATE pulse to 10% RF output voltage
Harmonics	Odd: -20dBc typical, -10dBc maximum Even: -30dBc typical, -20dBc maximum Measured at 1dB below rated output power
Spurious	<-70dBc maximum
Output noise (blanked)	<10dB above thermal (100kHz bandwidth)
Phase change/power	<10° from -40dB to full power
Phase stability	<1° across 100ms pulse
Output sample	-60dB into 50 Ω (forward voltage sample)
Input/output impedance	50 Ω nominal
Load VSWR	Tolerates at least 3:1 @ full rated power without shut down
Gain control range	10dB minimum for 0-5V control voltage Control via parallel interface
RF Input	0dBm nominal, 10dBm for no damage
GATE (blanking)	Logic low = Blank, logic high = unblank. CMOS and TTL compatible

Electrical Specifications

Mains supply voltage	110-240V, 50-60Hz, single phase
Rated power	1kVA maximum per inlet
Mains inlet	3 x IEC inlet (mains power cords supplied)

Typical Performance Plots

Peak output power at 1dB compression

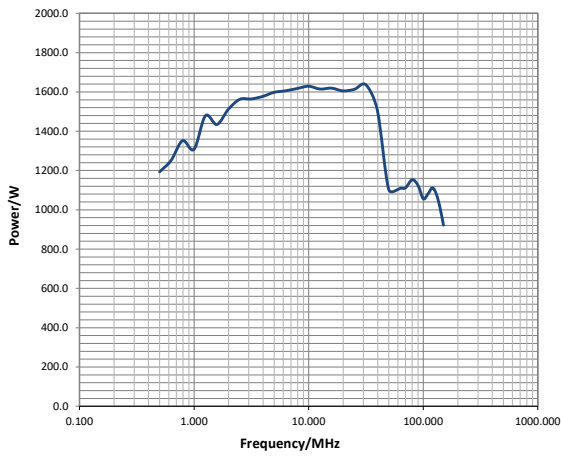

Harmonics

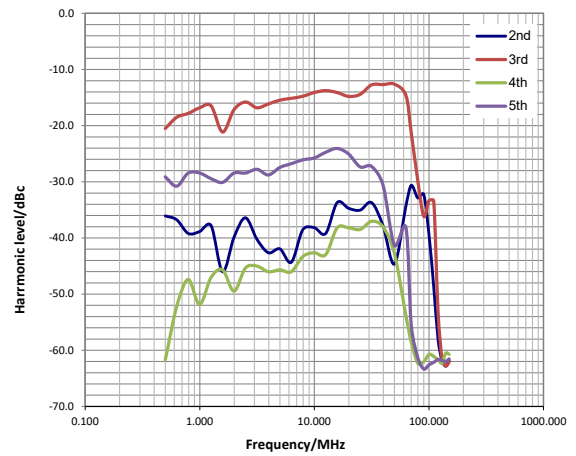

Peak output power for 0dBm RF drive

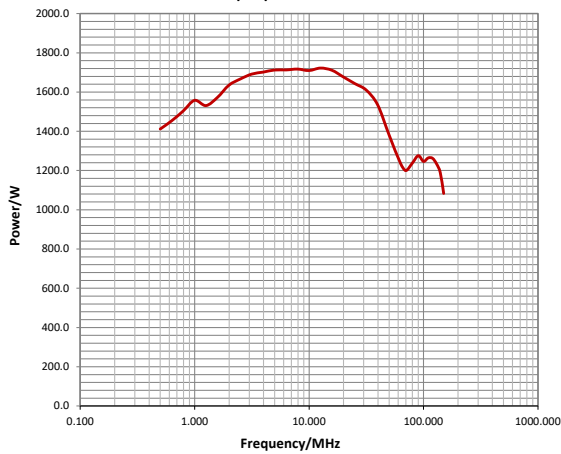

Gain as a function of input power

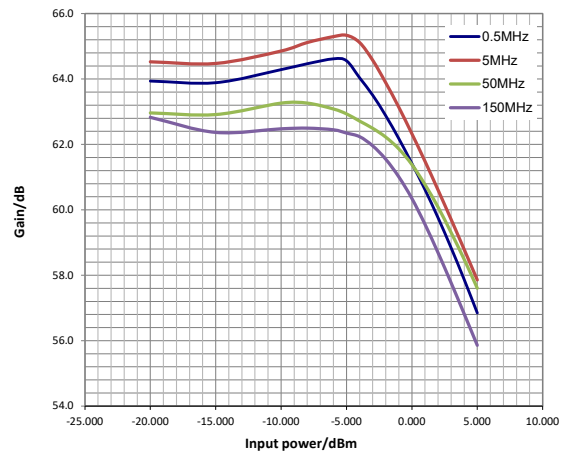

Maximum input power for auto-CW operation

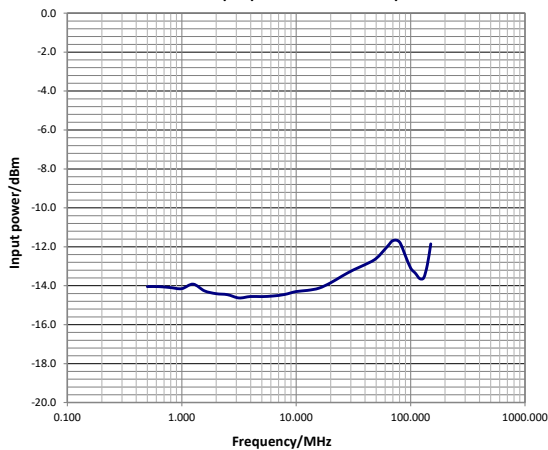

Small signal gain measured at 10% of maximum rated power

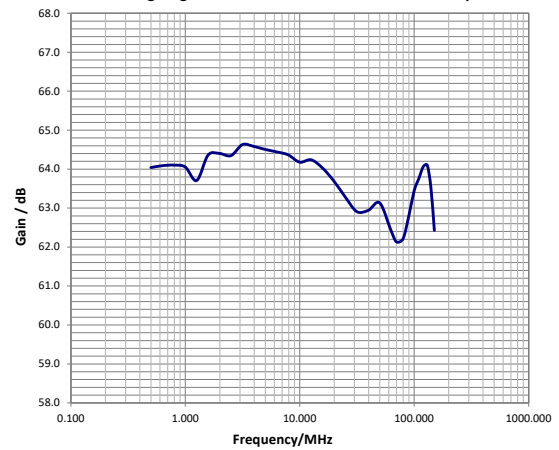

RF Amplifier Data Sheet

Mechanical Specifications

Connectors	RF IN: BNC female GATE: BNC female RF SAMPLE: BNC female RF OUT: N type female INTERFACE: DB25 female Other connectors types available on request
Dimensions	Chassis size: 450mmW (17.7"W) x 500mmD (19.7"D) x 216mmH (8.5"H) Total size: 482mmW (19"W) x 563mm (22.2"D) x 220mm (8.7"H) Rack compatibility: 19" 5RU
Weight	approx. 24kg (53lbs)
Enclosure classification	IP20

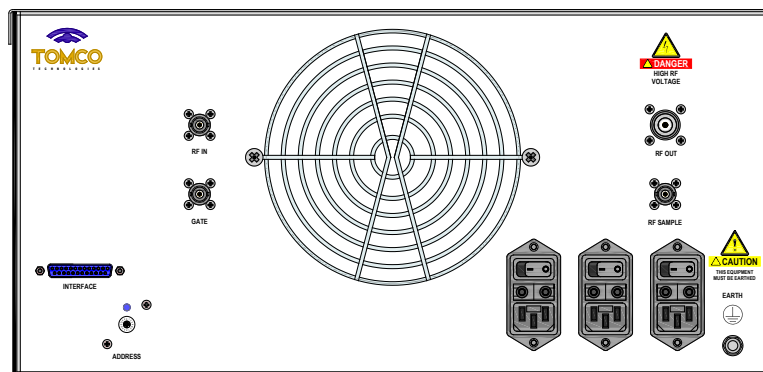
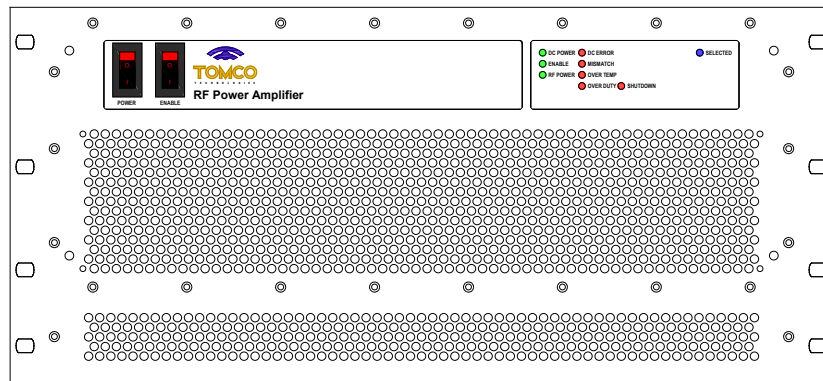
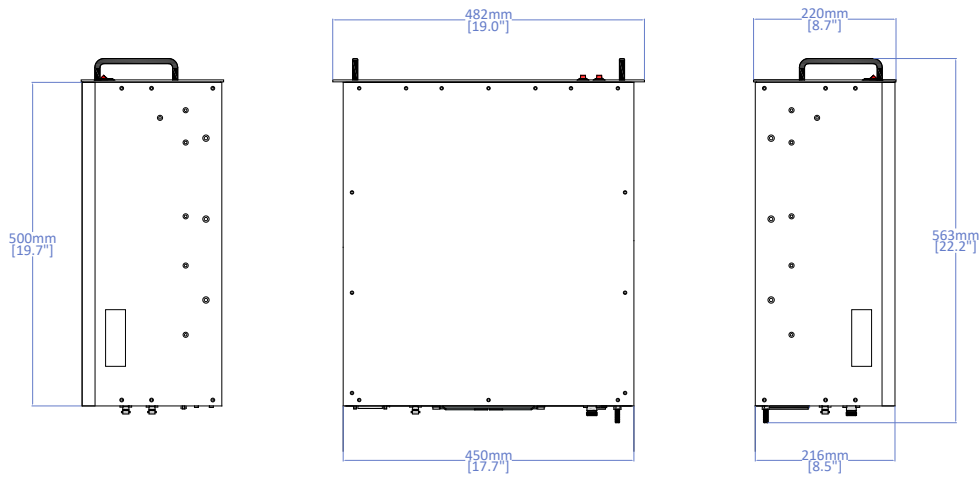





Protection

Load VSWR	Tolerates up to VSWR 3:1 at full rated power without shutdown Self-resetting shutdown protection activates if VSWR limits are exceeded
Over temperature	Self-resetting shutdown protection activates if thermal limits are exceeded
Duty cycle	Duty cycle limit is determined from the GATE signal duty cycle. Self-resetting shutdown protection activates if duty cycle limit is exceeded If output power is less than approx. 10% of maximum rated power, duty cycle protection is disabled and auto-CW operation is available
Pulse width	Pulse width limit is determined from the GATE signal pulse width. Self-resetting shutdown protection activates if pulse width limit is exceeded

Monitoring and Control

Front panel switches	Power (turns on DC power) Enable (enables RF)
Front panel LEDs	<ul style="list-style-type: none"> • DC POWER • ENABLE • RF POWER • DC ERROR • MISMATCH • OVER TEMP • OVER DUTY • SELECTED • SHUTDOWN
Parallel interface	25-pin D-connector (pinout available at www.tomcorf.com/pdf/interface.pdf)*

	Output signal indicating normal operation
	Output signal indicating fault condition
	Output signal for information only
	Input signal

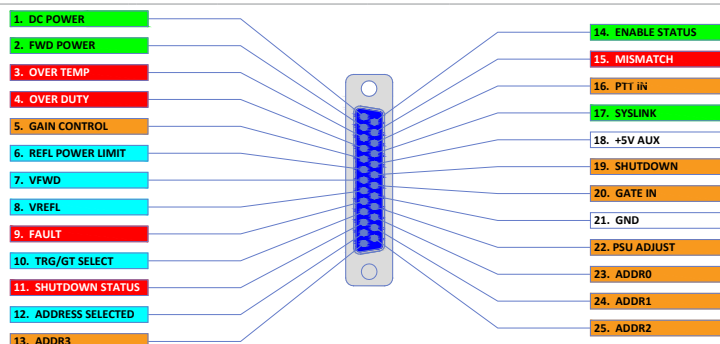

*Some functions may be unavailable on select amplifier models

Environmental

General	Intended for use only in controlled, indoor environment. Non-consumer product for industrial and scientific use. This product is not authorised for stand-alone on-air use. Additional systems, hardware and considerations are required to meet local spectral management regulations. Compliance of the final complete system is the responsibility of the end user.
Cooling	Forced air, front to rear
Operating temperature	+5°C to +40°C
Storage temperature	-20°C to +60°C
Humidity	80% for temperature up to 31°C, decreasing linearly to 50% relative humidity at 40°C
Operating altitude	Up to 2000m
Pollution degree	2
Transient voltage compatibility	Category II, in line with IEC 60364-4-44:2007
Electromagnetic compatibility	In line with IEC61326-1:2012 ISM equipment, Group 1, Class A For use only in shielded areas. ENC55011 (CISPR 11) limits exceeded by up to 50dB For use with isolated mains source. IEC61000-3-3:2013 (flicker) limits may be exceeded during high power pulsed operation
Safety	In line with IEC61010-1:2010
Electromagnetic field strength	In line with ICNIRP Guidelines: 1998, occupational limits

Change record

Document/Issue number	Originator	Date	Change
DS006677A	JR	18/07/2018	Original
DS006677B	JR	19/12/2018	p.1:ES
DS006677C	LS	06/05/2020	p.4:E
DS006677D	DW	10/09/2020	p.1:RFS
DS006677E	LS	12/01/2021	p.1:H
DS006677F	TD	8/12/2022	p.4:E