

BT00500-AlphaSA-CW 0.5MHz-150MHz 500W

- Scientific and Industrial Applications



The BT-AlphaSA-CW series is a range of class AB RF power amplifiers covering the 0.5MHz to 150MHz frequency range.

- Rugged, solid-state design - high reliability
- Extremely high phase and amplitude stability
- Very fast pulse rise/fall times
- High linearity
- Very low interpulse noise
- Competitively priced

RF Specifications

Type	Class AB
Rated Power	500W minimum PEP for input power of 0dBm Output power is limited to approx. 600W
P1dB	400W minimum Minimum output power at P1dB compression
Gain	57dB minimum
Type	Class AB MOSFET
Frequency	0.5MHz-150MHz
Gain flatness	±1.5dB maximum (measured at 1/10th rated output power)
Pulse droop (in pulsed operation)	0.5dB maximum Measured at max. pulse width at P1dB level
Pulse rise and fall times (in pulsed operation)	Risetime: 200ns typical Falltime: 100ns typical using a pre-gated RF input signal
Gate rise and fall times (in pulsed operation)	Risetime: 300ns typical Falltime: 150ns typical
Gate delay (in pulsed operation)	Rising edge: 1µs typical Falling edge: 500ns typical Rising edge measured from rising edge of GATE pulse to 90% RF output voltage. Falling edge measured from falling edge of GATE pulse to 10% RF output voltage
Harmonics	Odd: -20dBc typical, -10dBc max. Even: -30dBc typical, -20dBc max. Measured at 1dB below rated output power
Spurious	<-70dBc maximum
Output noise (blanked)	<10dB above thermal (100kHz bandwidth)
Phase change/power	<10° from -40dB to full power
Phase stability	<1° across 100ms pulse
Output sample	-50dB into 50 Ω (forward voltage sample)
Input/output impedance	50 Ω nominal
Load VSWR	Tolerates at least 2:1 @ full rated power without foldback
Gain control range	10dB minimum for 0-5V control voltage Control via parallel interface
RF Input	0dBm nominal, 10dBm for no damage
GATE (blanking)	Logic low = Blank, logic high = unblank. CMOS and TTL compatible

Electrical Specifications

Mains supply voltage	180-240V, 50-60Hz, single phase
Rated Power	1.7kVA maximum
Mains inlet	1 x IEC inlet (mains power cord supplied)

Typical Performance Plots

Peak output power for 0dBm RF drive

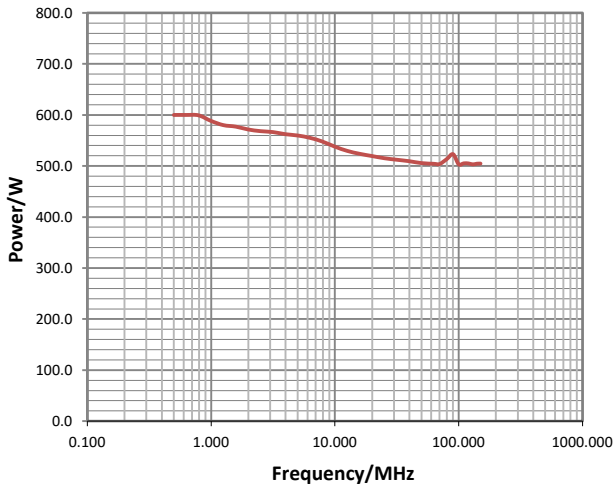

Harmonics

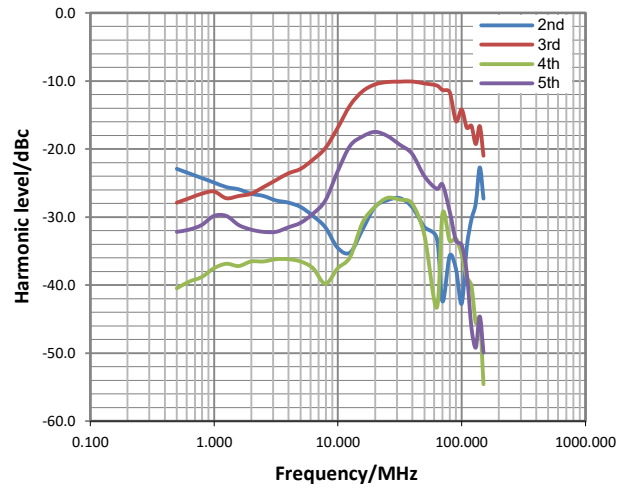

Peak output power at 1dB compression

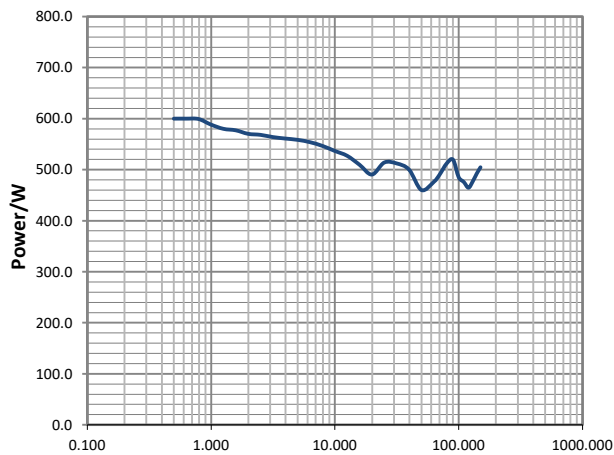

Gain as a function of input power

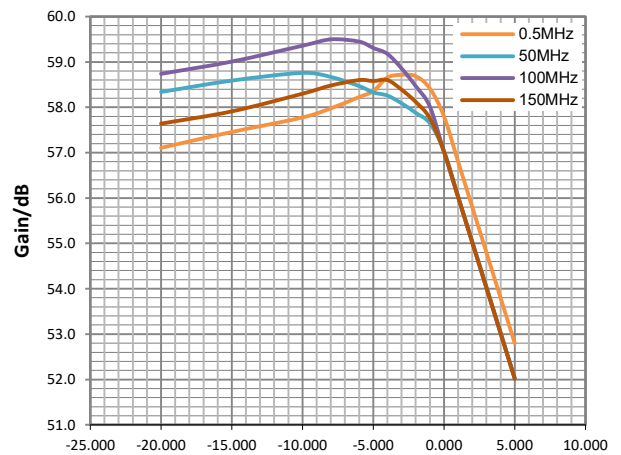

RF Amplifier Data Sheet

Mechanical Specifications

Connectors	RF IN: BNC female GATE: BNC female PTT: BNC female RF SAMPLE: BNC female RF OUT: N type female INTERFACE: DB25 female Other connectors types available on request
Dimensions	Chassis size: 450mmW (17.7"W) x 500mmD (19.7"D) x 216mmH (8.5"H) Total size: 482mmW (19"W) x 563mm (22.2"D) x 220mm (8.7"H) Rack compatibility: 19" 5RU
Weight	approx. 28kg (62lbs)
Enclosure classification	IP20

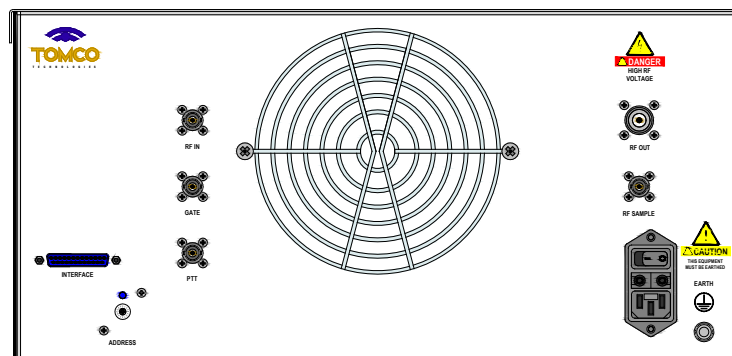
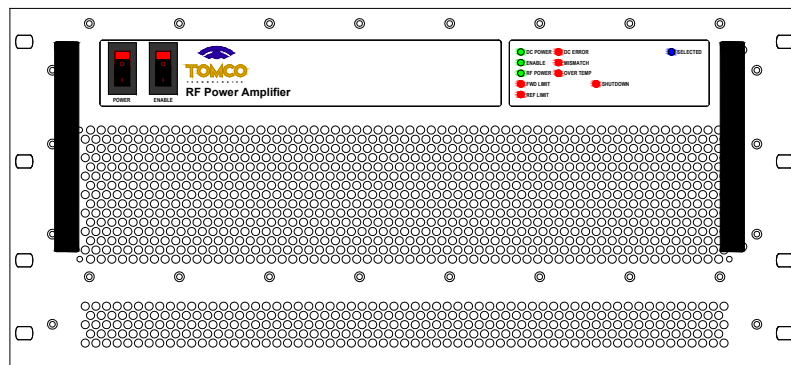
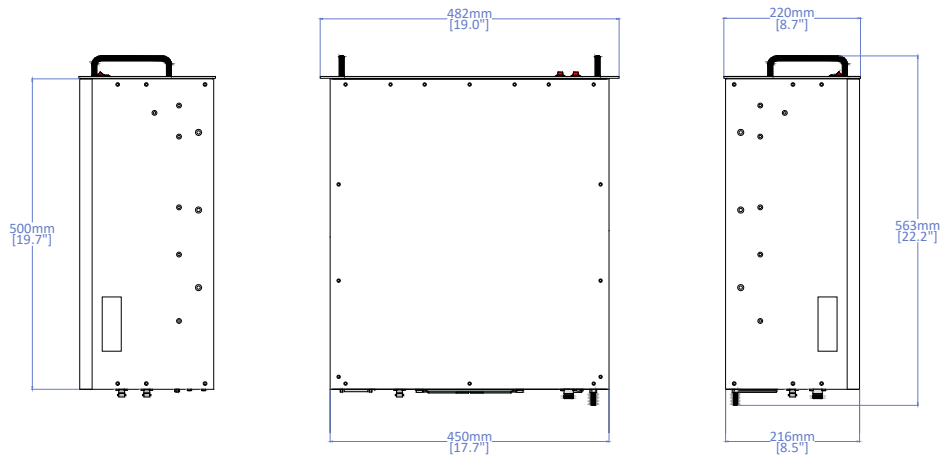





Protection

Load VSWR	Tolerates up to VSWR 2:1 at full rated power without foldback Self-resetting foldback protection which automatically reduces amplifier gain activates if VSWR limits are exceeded Under these conditions the REF LIMIT LED activates An additional circuit provides self-resetting shutdown protection against fast transient reflected power Under these conditions the MISMATCH LED activates
Over temperature	Self-resetting shutdown protection activates if thermal limits are exceeded
Forward power limiting	Limits forward output power to a maximum level

Monitoring and Control

Front panel switches	Power (turns on DC power) Enable (enables RF)
Front panel LEDs	<ul style="list-style-type: none"> • DC POWER • ENABLE • RF POWER • FWD LIM • REF LIM • DC ERROR • MISMATCH • OVER TEMP • SELECTED • SHUTDOWN
Parallel interface	25-pin D-connector (pinout available at www.tomcorf.com/pdf/interface.pdf)*

-  Output signal indicating normal operation
-  Output signal indicating fault condition
-  Output signal for information only
-  Input signal

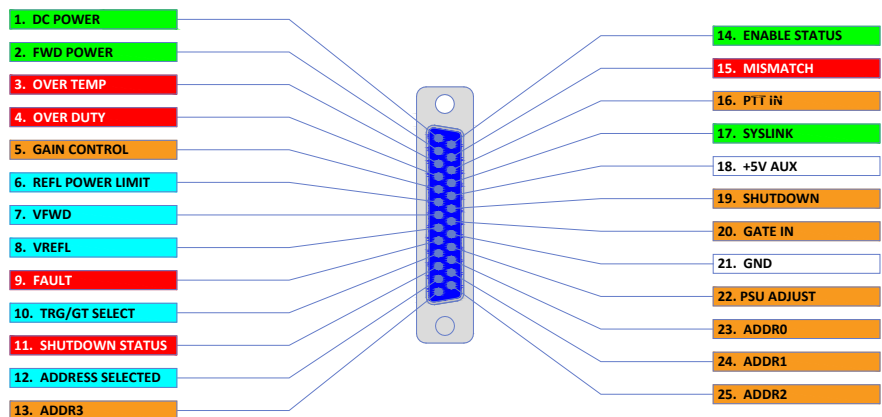

*Some functions may be unavailable on select amplifier models

Environmental

General	Intended for use only in controlled, indoor environment. Non-consumer product for industrial and scientific use
Cooling	Forced air, front to rear
Operating temperature	+5°C to +40°C
Storage temperature	-20°C to +60°C
Humidity	80% for temperature up to 31°C, decreasing linearly to 50% relative humidity at 40°C
Operating altitude	Up to 2000m
Pollution degree	2
Transient voltage compatibility	Category II, in line with IEC 60364-4-44:2007
Electromagnetic compatibility	In line with IEC61326-1:2012 ISM equipment, Group 1, Class A For use only in shielded areas. ENC55011 (CISPR 11) limits exceeded by up to 40dB
Safety	In line with IEC61010-1:2010
Electromagnetic field strength	In line with ICNIRP Guidelines: 1998, occupational limits

Change record

Document/Issue number	Originator	Date	Change
DS006703A	JR	21/08/2018	Original
DS006703B	LS	06/05/2021	p.1:H